





**Características | Especificaciones**

|   |  |
|---|--|
| <b>Material</b><br>Material                       | <b>Porcelana Vitrificada</b>   |
| <b>Descarga</b><br>Descarga                       | <b>Vertical</b>  |
| <b>Fixação</b><br>Fijación                        | <b>Ao Chão   Al Suelo</b>  |
| <b>Volumen de descarga</b><br>Volumen de descarga | <b>6L</b>  |
| <b>Garantia</b><br>Garantía                       |   |

**Cores | Colores**

White

**Desenho Técnico | Diseño Técnico**

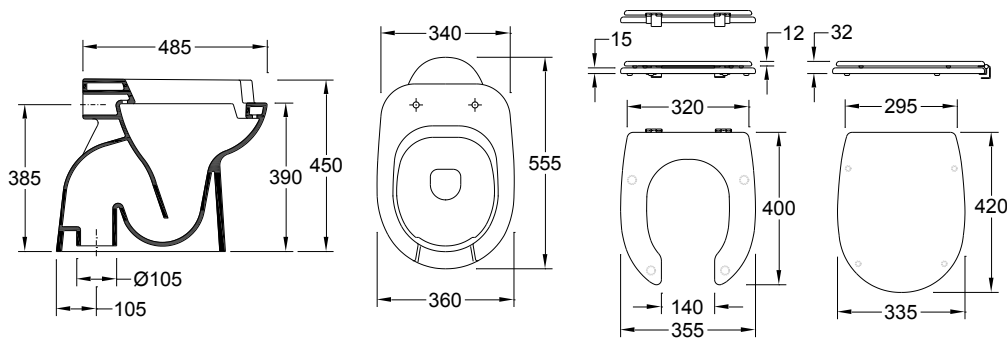

**Dimensões | Dimensiones (mm)**

|   |     |     |     |
|---|-----|-----|-----|
|  | L   | W   | H   |
| 22  | 555 | 360 | 450 |

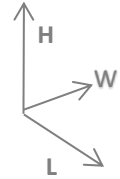









**Componentes | Componentes**

|                                |  |   |
|--------------------------------|--|---|
| <b>Incluído</b><br>Incluido    |  | <b>Bacia Normal PMR Descarga Vertical   Inodoro p/ Tanque Empotrado PMR Salida Vertical</b> |
|                                |  |   |
|                                |  |   |
|                                |  |   |
| <b>Necessário</b><br>Requirido |  | <b>Tanque Cerâmico ou Fluxómetro   Tanque Cerámico ou Fluxor</b>                            |
|                                |  | <b>Tanque Plástico ou Mecanismo   Tanque Plástico ou Mecanismo</b>                          |
|                                |  | <b>Tampo Normal ou Soft-close   Tapa normal o de cierre suave</b>                           |

**Recomendações | Recomendaciones<sup>1</sup>**



EN FR

| Material<br>Matériaux                 | Type of product<br>Type de pièce  | Detergents<br>Détergents                                     |   | Cleaning kit<br>Matériel de Nettoyage   |   | Other Recommendations<br>Autres Recommendations  |
|---------------------------------------|---|--|---|---|---|--|
|                                       |   | ✗  | ✓   | ✗   | ✓   |  |
| Ceramics<br>Céramique                 |  | Abrasives<br>Abrasifs  | Acid and basic weak<br>Neutral Soap<br>Acides et bases faibles<br>Savon Neutre        | ✗   | ✓   | <b>Attention / Attention</b><br> Not dropping objects<br>Évitez de faire tomber des objets  |
| Metallics<br>Métallique               |  | Acid and Basic<br>Acetone<br>Alcohol<br>Ammonia<br>Abrasives | Neutral Soap<br>Savon Neutre  | Abrasives<br>Abrasifs   | Cleaning Cloth<br>Chiffon doux  |  Weight on cover<br>Ne vous tenez pas sur la surface supérieure<br> Effort on soft-close<br>Ne forcez pas la descente en douceur |
| Plastics/Resins<br>Plastiques/Résines |  | Acides et Bases<br>Acétone<br>Alcool<br>Ammoniac<br>Abrasifs |  |  |  |  |

1. PT - Outras recomendações mais específicas podem acompanhar os produtos comercializadas. Recomendamos que siga as recomendações e instruções indicadas.  
EN - Other particular recommendations can be attached complementarily with the traded products. We strongly advise you to follow the recommendations and instructions indicated.



**Specifications | Spécifications**

|   |  |
|---|--|
| <b>Material</b><br>Matériel                   | <b>Vitreous China</b>  |
| <b>Outlet system</b><br>Évacuation            | <b>Vertical</b><br>Verticale   |
| <b>Fixing</b><br>Fixation                     | <b>To the Floor   Au Sol</b>   |
| <b>Discharge volume</b><br>Volume de décharge | <b>6L</b>  |
| <b>Warranty</b><br>Garantie                   |   |

**Colours | Couleurs**

White

**Technical Drawing | Dessin technique**

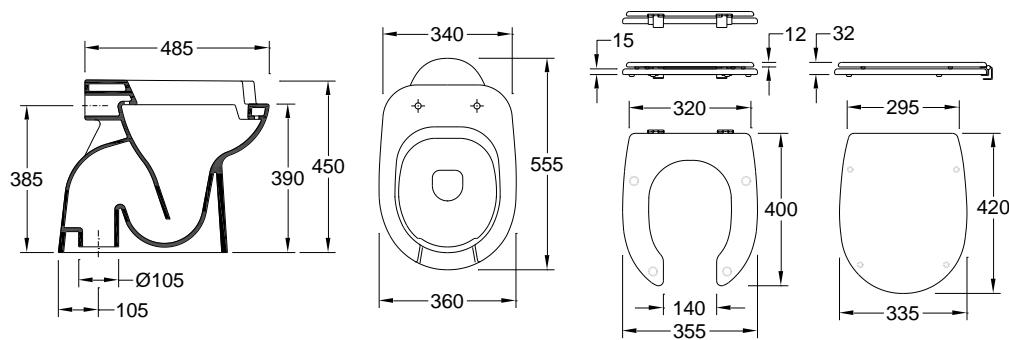

**Dimensions | Dimensions (mm)**



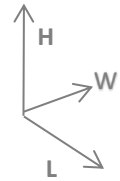















|   |     |     |     |
|---|-----|-----|-----|
|  | L   | W   | H   |
| 22  | 555 | 360 | 450 |



**Components | Composants**

|                               |  |
|-------------------------------|--|
| <b>Included</b><br>Inclus     | <b>Concealed WC PMR Vertical Outlet   Cuvette Normale PMR Sortie Verticale</b> |
|                               |  |
|                               |  |
|                               |  |
|                               |  |
| <b>Required</b><br>Nécessaire | <b>Ceramic Cistern or Flowmeter   Réservoir en céramique ou Fluxomètre</b>     |
|                               | <b>Plastic Cistern or Mechanism   Réservoir en plastique ou Mécanisme</b>      |
|                               | <b>Normal or soft-close Toilet seat   Abattant normal ou soft-close</b>        |

**Recommendations | Recommandations!**

| Material<br>Matériaux                 | Type of product<br>Type de pièce  | Detergents<br>Détergents  |   | Cleaning kit<br>Matériel de Nettoyage   |   | Other Recommendations<br>Autres Recommandations  |
|---------------------------------------|---|---|---|---|---|--|
|                                       |   |   |  |   |  |  |
| Ceramics<br>Céramique                 |  |  |  |  |  |  <b>Not dropping objects</b><br>Évitez de faire tomber des objets   |
| Metallics<br>Métallique               |  | Acid and Basic<br>Alcohol<br>Ammonia<br>Abrasives                                     | Neutral Soap<br>Savon Neutre  | Abrasives<br>Abrasifs   | Cleaning Cloth<br>Chiffon doux  |   <b>Weight on cover</b><br>Ne vous tenez pas sur la surface supérieure<br>  <b>Effort on soft-close</b><br>Ne forcez pas la descente en douceur |
| Plastics/Resins<br>Plastiques/Résines |  | Acides et Bases<br>Acétone<br>Alcool<br>Ammoniac<br>Abrasifs                          |  |  |  |  |

- PT - Outras recomendações mais específicas podem acompanhar os produtos comercializadas. Recomendamos que siga as recomendações e instruções indicadas.  
EN - Other particular recommendations can be attached complementarily with the traded products. We strongly advise you to follow the recommendations and instructions indicated.