

ESC. 1:2	Monocomando Embutir Duche 1 Via			
Desenhou 28/01/2021	SANITERRA [®]	MILANO SLIM		
Rev: 1 15/03/2022		1521016		

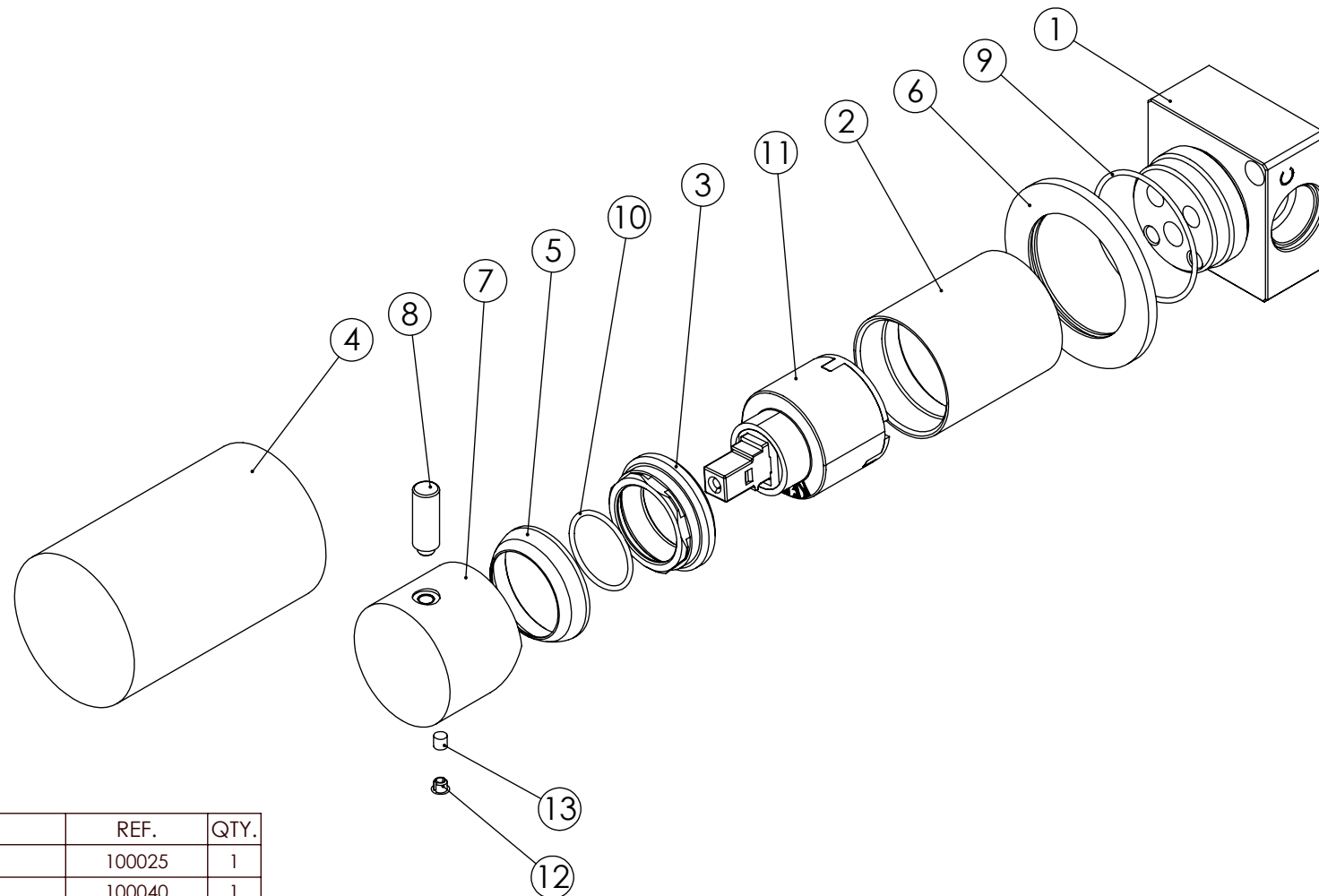

ITEM NO.	DESCRIPTION	REF.	QTY.
1	Bloco 1 Via	100025	1
2	Copo Cartuchos Embutidos	100040	1
3	Porca M37x1,5 C_Oring	100881	1
4	Box 1 Via 75x50x50	100611	1
5	Campânula Porca M37x1,5	100880	1
6	Espelho Parede P_SLIM090C1	100717	1
7	Manípulo Lavatório Cilíndrico P-Perno	100428	1
8	Rabo Manípulo Cilíndrico Embutidos	100167	1
9	Orings 40.00x1.50 NBR 70	021286	1
10	Orings 23.00x1.50 NBR 70	001098	1
11	Cartucho 35	AC540A	1
12	Dístico em ABS de 5.5mm Cromado	LH-PLCR4	1
13	Perno Umbrako Din 914 M4-5 Inox A-2	09140400050IN	1

ESC. 1:2	Monocomando Embutir Duche 1 Via		
Desenhou 28/01/2021	SANITERRA®	MILANO SLIM	
Rev: 1 15/03/2022		1521016	

SANITERRA[®] 1°

Service:

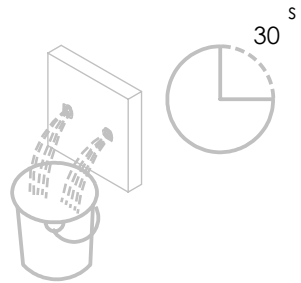
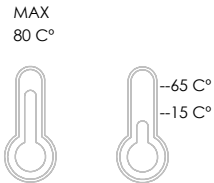

- Adjustable Pliers
- Screw Driver
- level
- 2mm

Washbasin Mixer Installation Manual

2°

Conection:

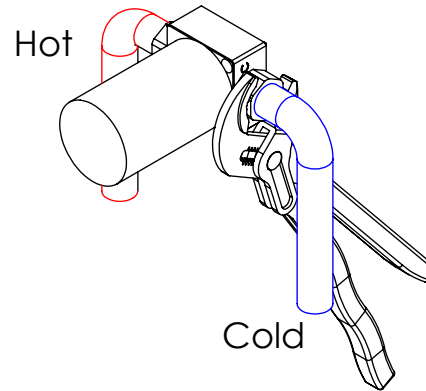

3°

Fixed:

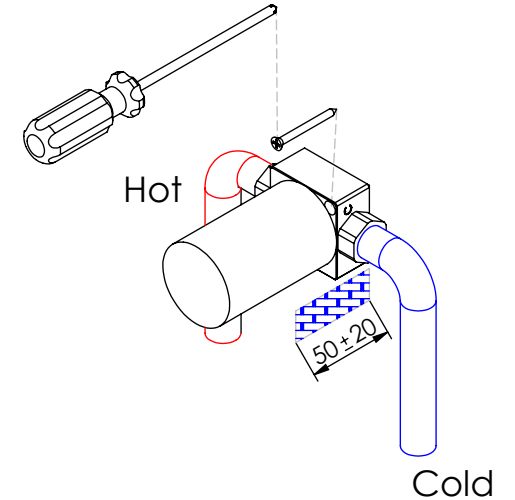

4°

Remove Protection:

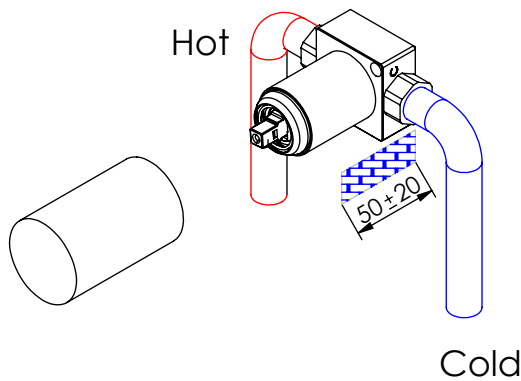

5°

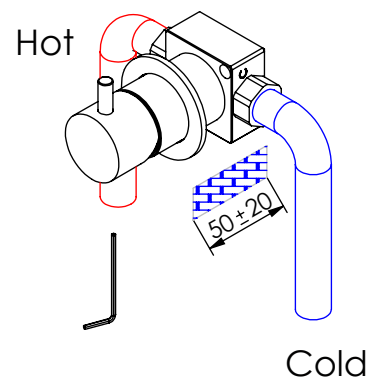

Maintenance:

